

WR-28 to 2.4mm Adapter

AT-WC-2824X-R

Feature

- WR-28 to 2.4mm Adapter
- Specified 26.5-40GHz
- Low Insertion Loss
- Excellent Broadband VSWR



Specifications -

Specifications guaranteed from -45 to +85°C, measured in a 50Ω system

Parameter	Frequency Range(GHz)	Min	Typ	Max	Unit
Insertion Loss	26.5-40GHz		0.5	1	dB
VSWR			1.25	1.3	
Power Handling				50	W
Specifications Temp				25	C
Operating Temp		-40		85	C

Environmental

- 55 C to +125 C
- Corrosion: MIL-STD 202
- Vibration: MIL-STD 202

Materials

- Waveguide Housing: Brass, Gold Plated
- Connector Housing: Stainless steel, Passivated
- Connector Center Contact: Beryllium Copper, Gold Plated
- Connector Insulator: PE

Order Information

Connector #1	Connector #2	Part Number
WR-28	2.4mm Female	AT-WC-2824F-R
WR-28	2.4mm Male	AT-WC-2824M-R

Dimension

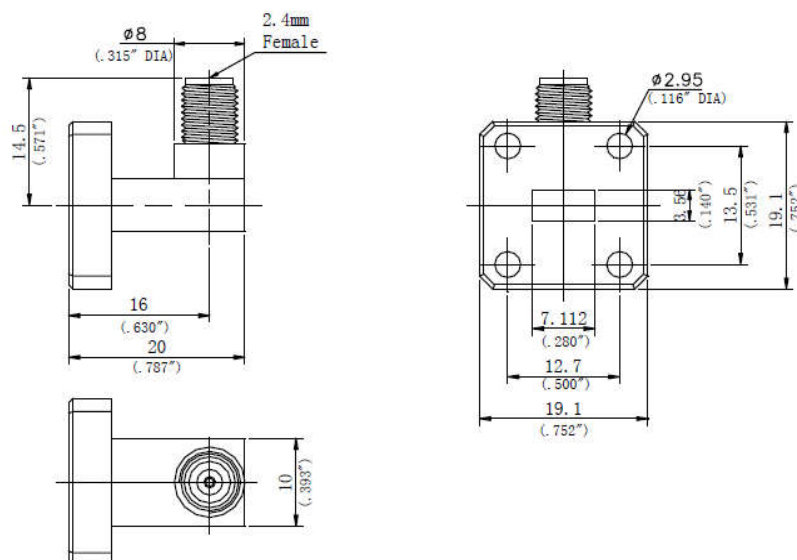

AT Microwave

RM1204,NO.2911, North Zhongshan RD, Putuo District , Shanghai ,China, 200063

Tel:+8621-5291 8556 Email:sales@atmicrowave.com www.atmicrowave.com