

6Ways Wilkinson Power Divider/Combiner

AT-PD6-1840

REV A

Feature

18-40 GHz Broadband

Low Insertion Loss

Outstanding Phase and Amplitude Balance

Electrical Specifications -

Specifications guaranteed from -45 to +85°C, measured in a 50Ω system

Parameter	Frequency Range(GHz)	Min	Typ	Max	Unit	
Normal Power Splitting	18-40GHz		8		dB	
Normal Phase Shift			0		Degree	
Amplitude Balance			+/-0.5		dB	
Phase Balance			+/- 6		Degree	
Insertion Loss				2.2		dB
VSWR				1.7		
Isolation				18		dB
CW Peak				20		W
Peak Power				3000		W
Weight				310		g
Dimension(L/W/H)			45.7x88.9x12.7			mm

Order Information

Part Number	Description
AT-PD6-1840	6Ways 18-40GHz Power Divider With SMA Female Connectors

Consult factory for other connectors option

Dimension

Unit: mm/Degree

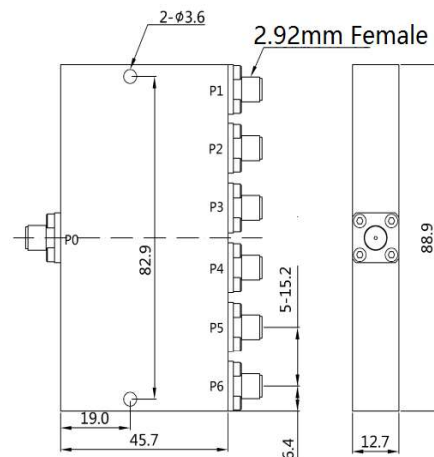

AT Microwave

RM1204,NO.2911,North Zhongshan RD, Putuo District , Shanghai ,China, 200063

Tel:+8621-6229 1233 Email:sales@atmicrowave.com www.atmicrowave.com

6Ways Wilkinson Power Divider/Combiner

AT-PD6-1840

Typical Performance

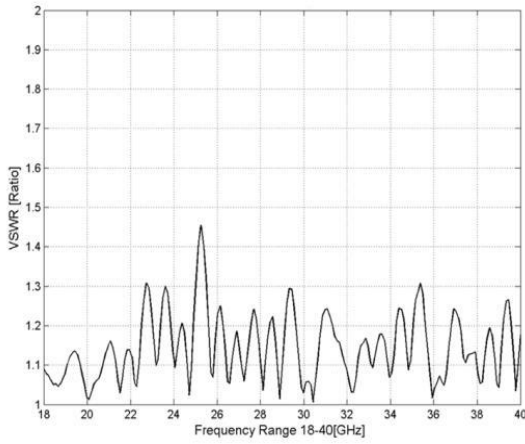

Figure 1: Input Port VSWR

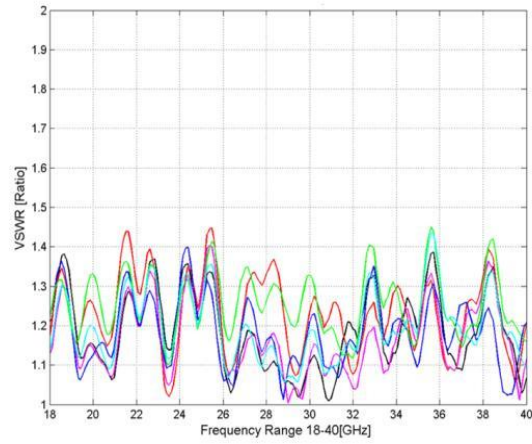

Figure 2: Output Port VSWR

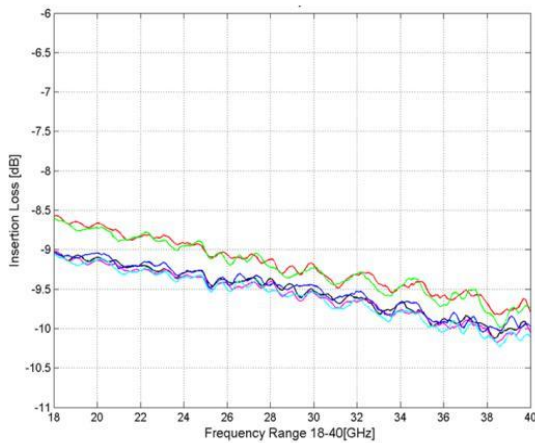

Figure 3: Insertion Loss

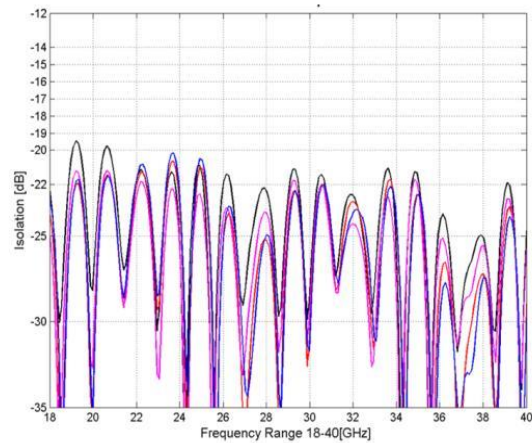

Figure 4: Output Port Isolation

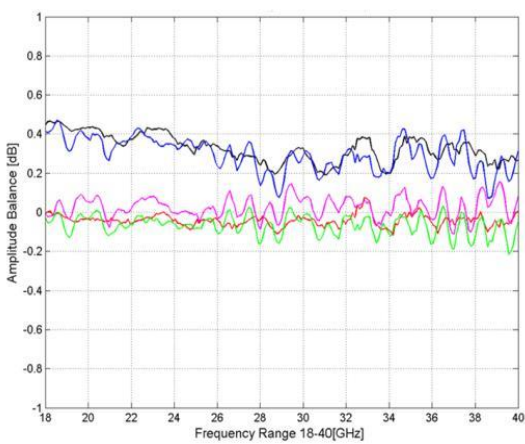

Figure 5: Output Port Amplitude Balance

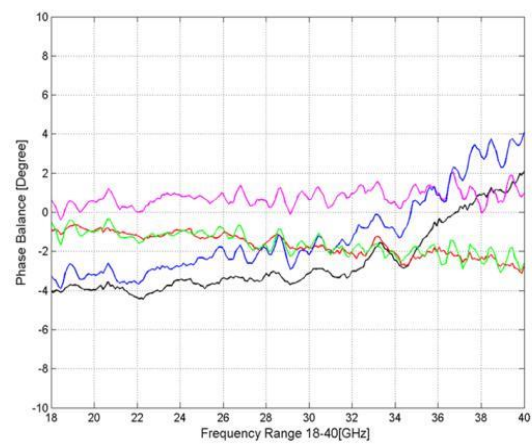

Figure 6: Output Phase Balance

AT Microwave reserves the right to make changes to the information contained herein without notice.

AT Microwave

RM1204,NO.2911,North Zhongshan RD, Putuo District , Shanghai ,China, 200063

Tel:+8621-6229 1233 Email:sales@atmicrowave.com www.atmicrowave.com