



AT-LNA-5566-1506VG

55-66GHz Low Noise Amplifier

V Band Low Noise Amplifier

55-66GHz, Gain=15dB, NF=6dB, 1.85mm Female



Product Overview

AT-LNA-5566-1506VG is Low Noise Amplifier with 6dB Noise Figure in the frequency of 55-66GHz. The DC power requirement is +5V/90mA. The module is with 1.85mm Female

AT Microwave can provide all kinds of coaxial low noise amplifiers, with frequency from 0.01-67GHz, gain from 20 to 66dB, Pout from +5 to +27dBm, and connectors from SMA to 1.85mm.

More information, please visit www.atmicrowave.com

Advantages

- ✓ Frequency: 55-66GHz
- ✓ Small signal gain: 15dB
- ✓ Noise Figure: 6dB
- ✓ Single Power Supply

Application

- ✓ V Band Communication
- ✓ Test Equipment
- ✓ ROF (RF Over Fiber)
- ✓ Radar System

Key Features

Parameter	Min	Typical	Max
Frequency		55-66GHz	
Gain	13dB	15dB	
NF		6dB	8dB
P1dB		+7dBm	
Psat	+8dBm	+10dBm	
Drain Supply		+5V	+8V
Current		90 mA	120mA
Input Return Loss		-7 dB	
Output Return Loss		-7 dB	
Spec Temp		25C	





AT-LNA-5566-1506VG

55-66GHz Low Noise Amplifier

Mechanical Information

Item	Description
Input Port	1.85mm Female
Output Port	1.85mm Female
Case Material	Copper
Finish	Gold Plated
Package Sealing	Epoxy Sealed
Weight (Without Heatsink)	50g
Size:	30x30x14 mm

Absolute Maximum Ratings Table

Parameter	Value
Drain Supply	+13V
RF Input Power	+10dBm
Operating Temperature	-40 to +85C
Storage Temperature	-55 to +125C

Notes:

1. Datasheet may be changed according to update of MMIC, Raw materials , process, and so on.
2. This data is only for reference, not for guaranteed specifications.
3. Please contact AT Microwave team to make sure you have the most current data.

Part Number Selection Guide

Item	Description
PN	Stand Module with DC Power Supply
PN-LCBT	L ow Cost, C ompact B ench- T op, +220V Supply with AC/DC Adapter

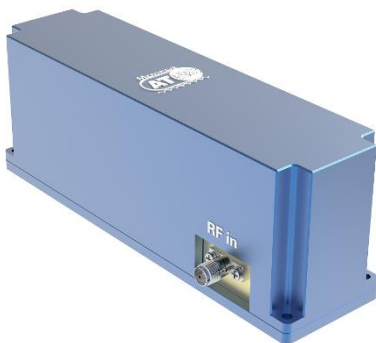

Test Data(25C)

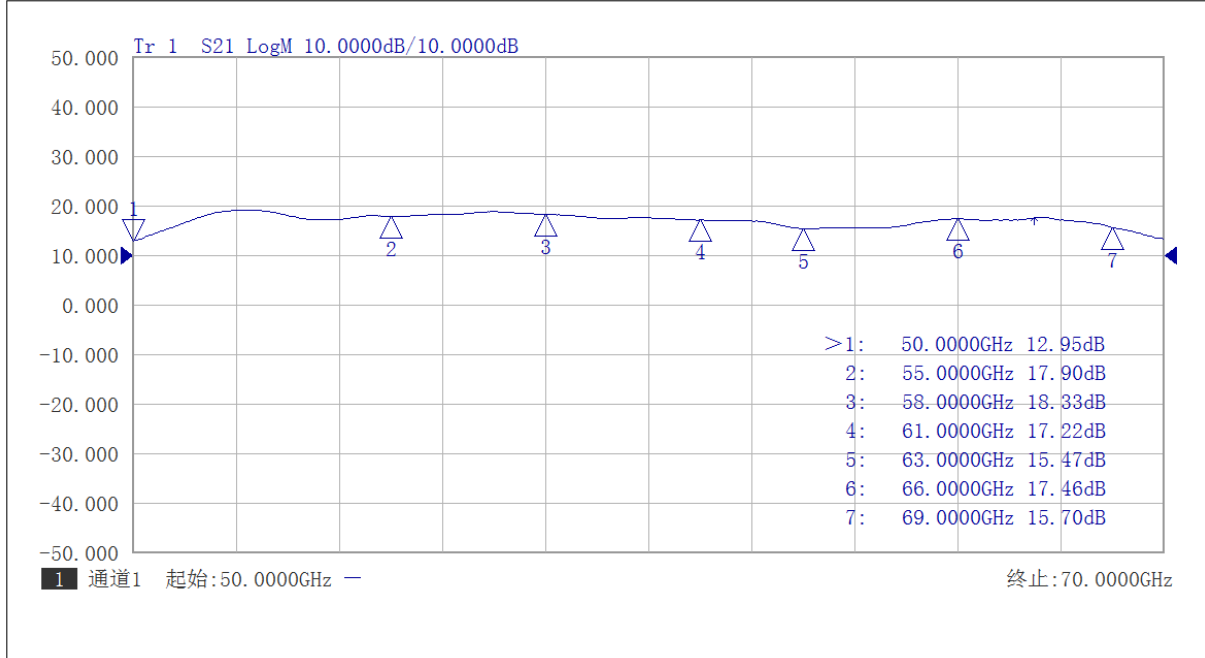

Gain vs Frequency

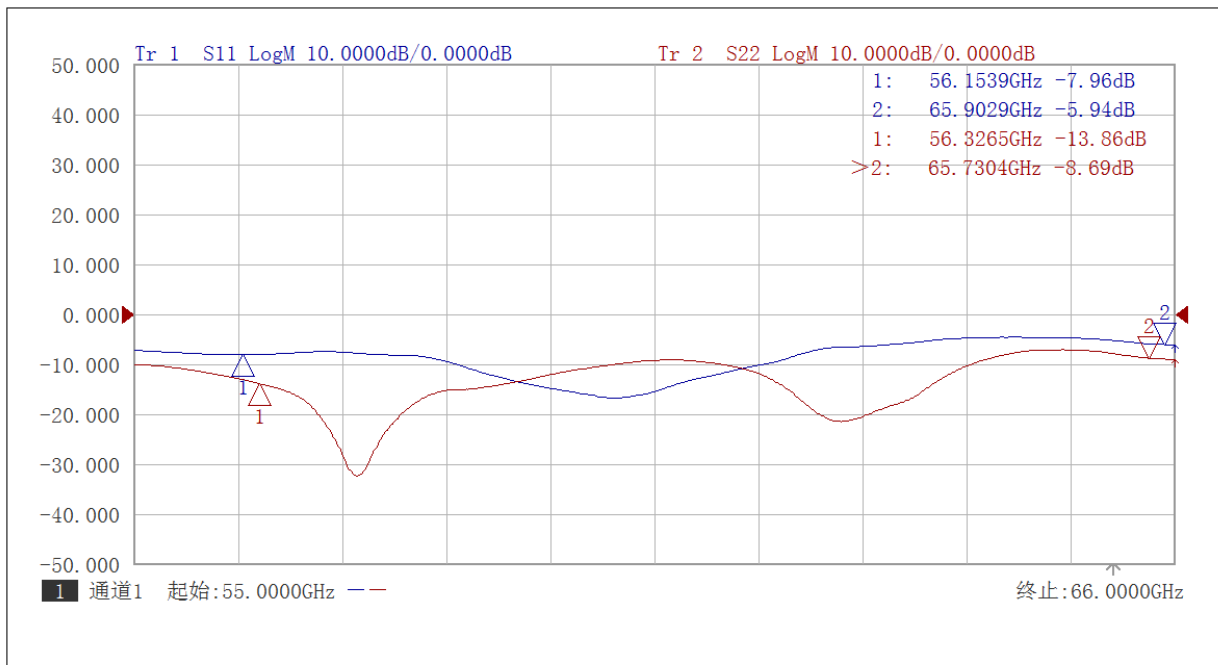

Return Loss vs Frequency



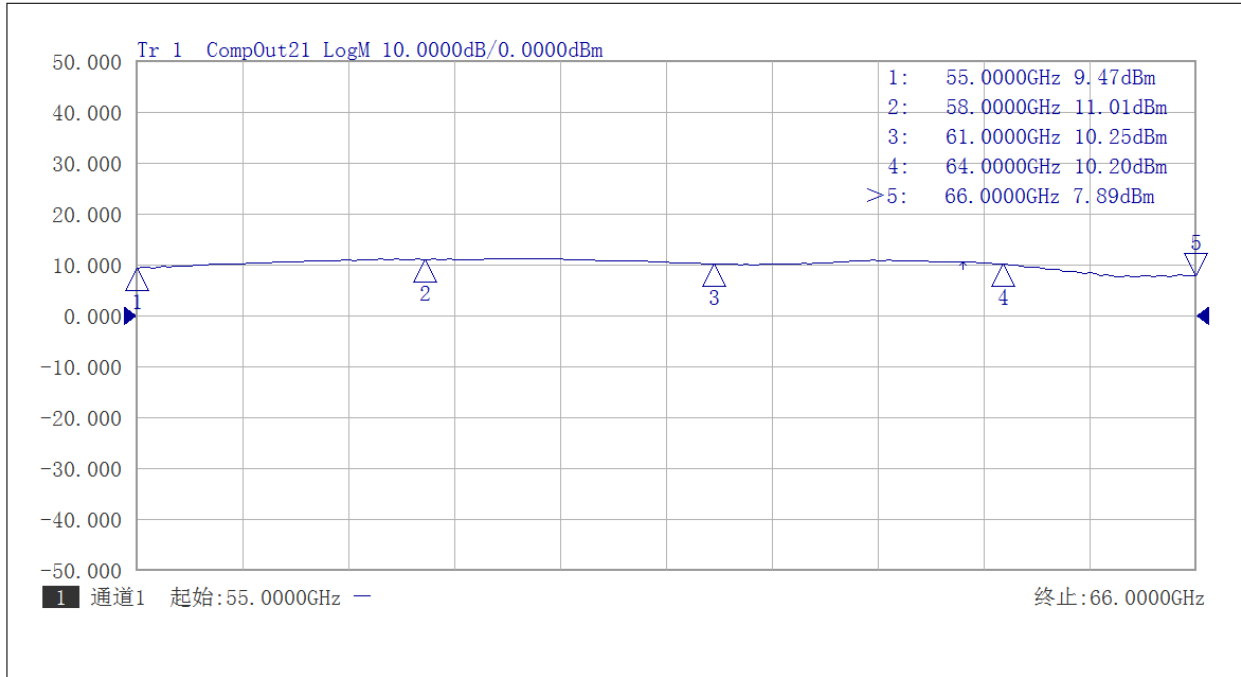

P1dB vs Frequency

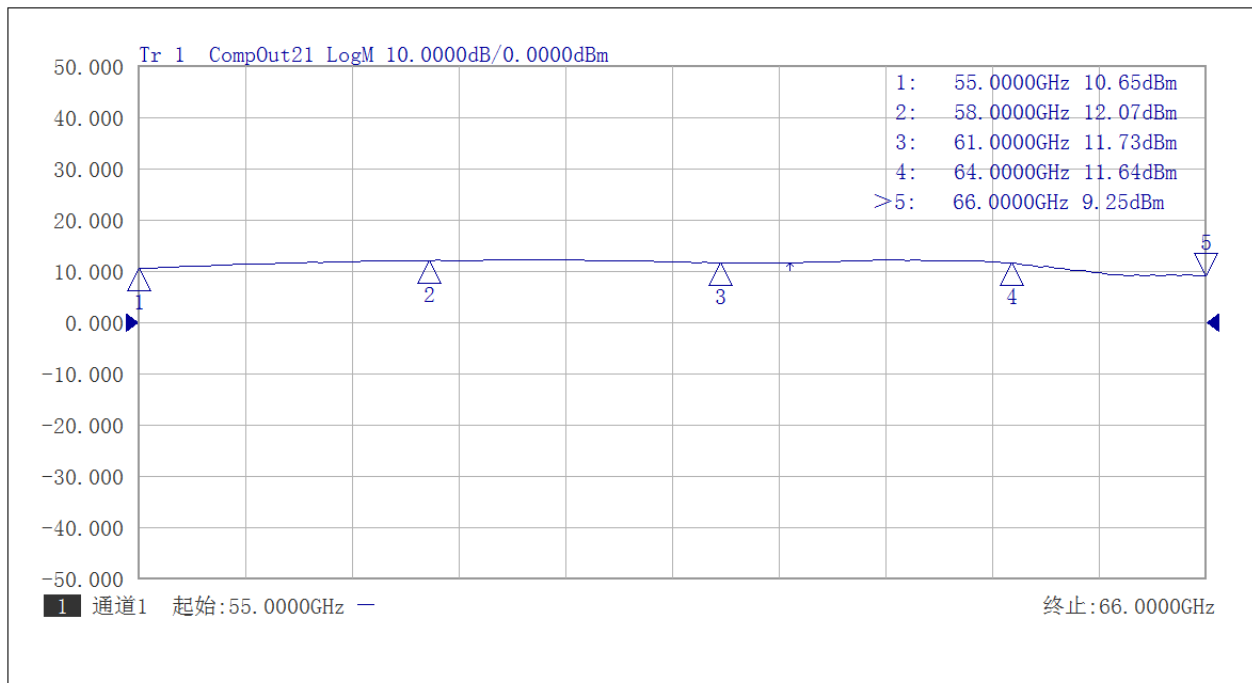

P3dB vs Frequency





AT-LNA-5566-1506VG

55-66GHz Low Noise Amplifier

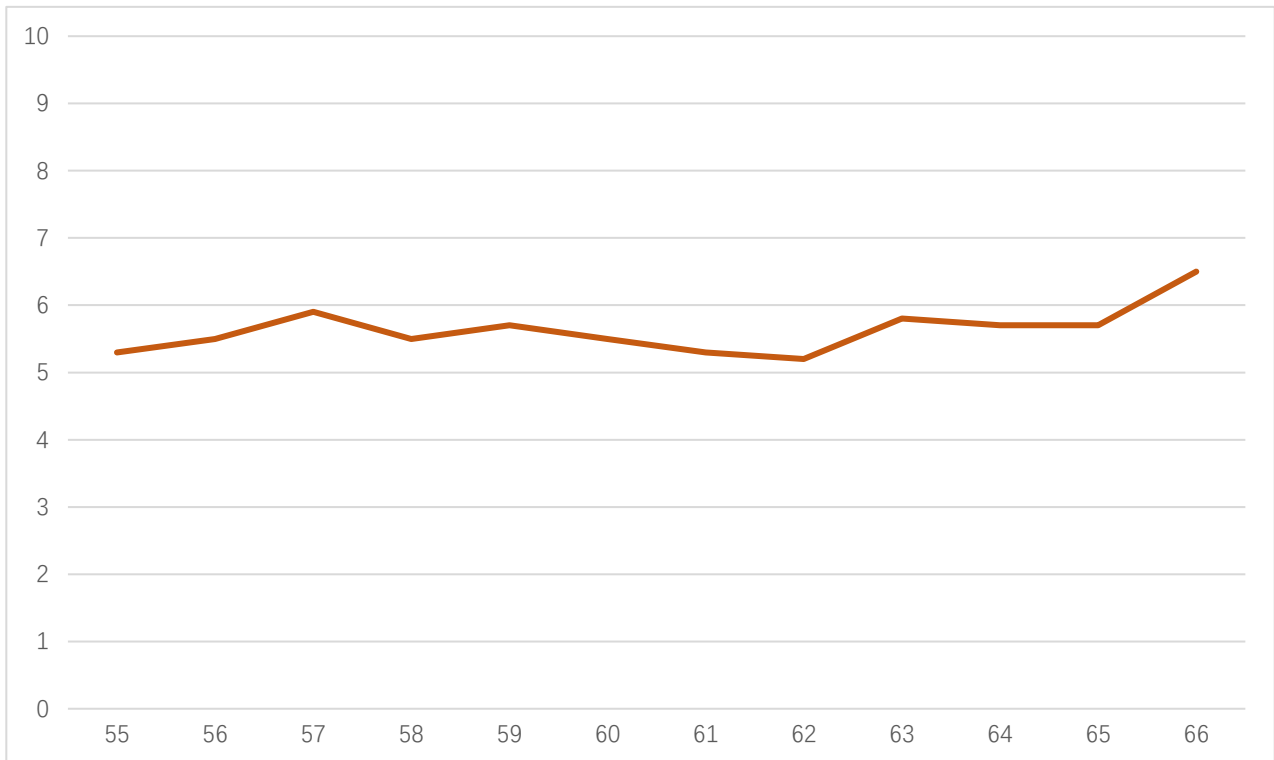

NF vs Frequency



Dimension: (unit in mm)

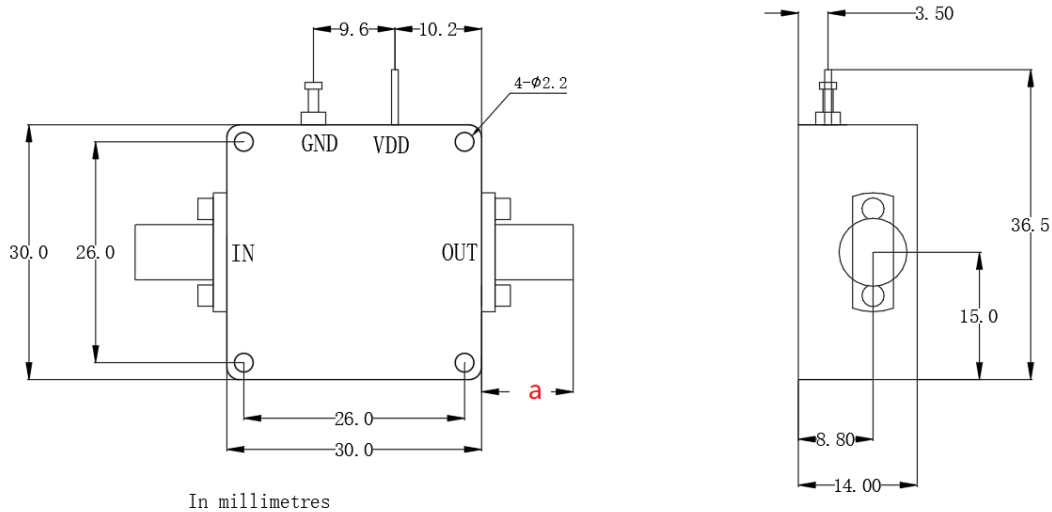

	<26.5GHz	<40GHz	<50GHz	<67GHz
Connector	SMA	2.92mm	2.4mm	1.85mm
Length of a	9.4mm	9.5mm	10.8mm	11.3mm

Note: Female Default. Contact with us for other types.

