

50kHz-40GHz Broadband Low Noise Amplifier



Product Overview

AT-LNA-0040-2304Y broadband low noise amplifier from 50kHz to 40GHz. The NF is 4dB from 100MHz-40GHz. The DC power requirement is +5V/170mA. The module is with 2.92mm Female. 2.4mm connector is available according to request.

NF no guarantee for 50kHz to 100MHz. AT Microwave can provide all kinds of coaxial low noise amplifiers, with frequency from 0.01-67GHz, gain from 20 to 60dB, Pout from +5 to +27dBm, and connectors from SMA to 1.85mm.

More information, please visit www.atmicrowave.com

Advantages

- ✓ Frequency: 50kHz-40GHz
- ✓ Small signal gain: 23dB
- ✓ Noise Figure 4dB
- ✓ Single Power Supply

Application

- ✓ Broadband Communication
- ✓ Test Equipment
- ✓ ROF (RF Over Fiber)
- ✓ Radar System

Key Features

Parameter	Min	Typical	Max
Frequency	50kHz	100MHz-40GHz	
Gain	20dB	23dB	
Gain Flatness		+/-2dB	+/-3dB
NF(0.1-40GHz)		4dB	6
P1dB		+10dBm	
Psat		+13dBm	
Drain Supply		+5V	+8V
Current		170 mA	200mA
Input Return Loss		-12 dB	
Output Return Loss		-12 dB	
Phase Delay		235ps	
Spec Temp		25C	





AT-LNA-0040-2304Y

50kHz-40GHz Low Noise Amplifier

Mechanical Information

Item	Description
Input Port	2.92mm Female
Output Port	2.92mm Female
Case Material	Copper
Package Sealing	Epoxy Sealed
Finish	Gold Plated
Weight (Without Heatsink)	50g
Size:	30x30x14 mm

Absolute Maximum Ratings Table

Parameter	Value
Drain Supply	+13V
RF Input Power	+10dBm
Operating Temperature(note)	-20 to +70C
Storage Temperature	-65 to +150C

Note: -40 to +85C is available according to request.

Caution:

Please pay attention to the case temperature. If case temperature exceed higher than +50C, heat sink and fan are required, or the amplifier may be damaged.

Notes:

1. Datasheet may be changed according to update of MMIC, Raw materials , process, and so on.
2. This data is only for reference, not for guaranteed specifications.
3. Please contact AT Microwave team to make sure you have the most current data.



Test Data:

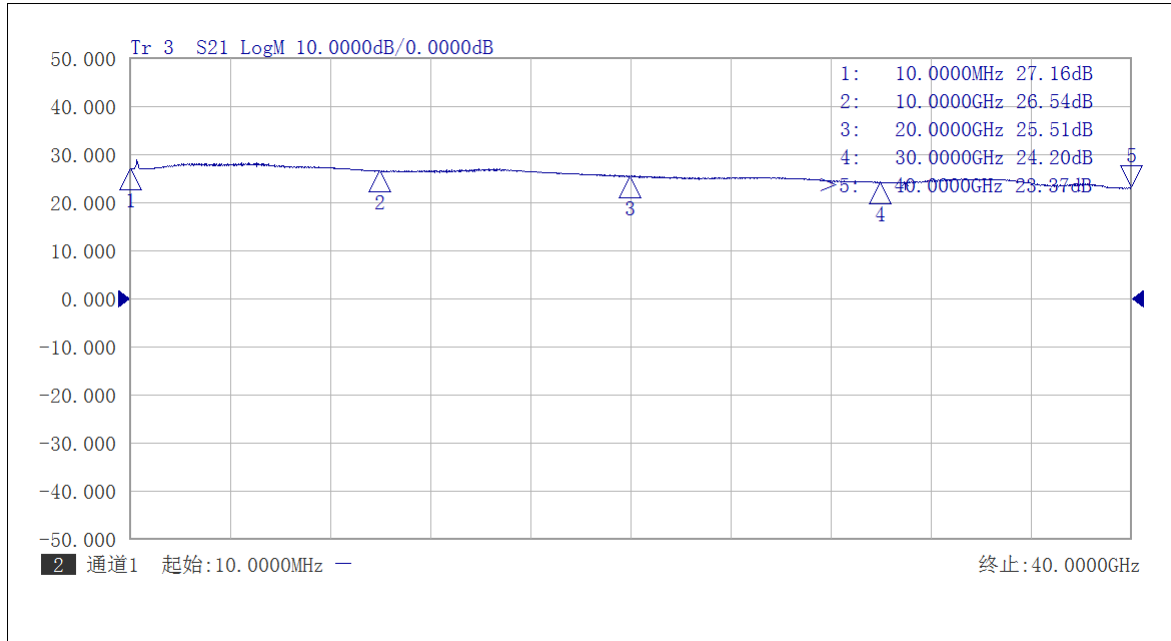

Gain vs Frequency from 10MHz-40GHz

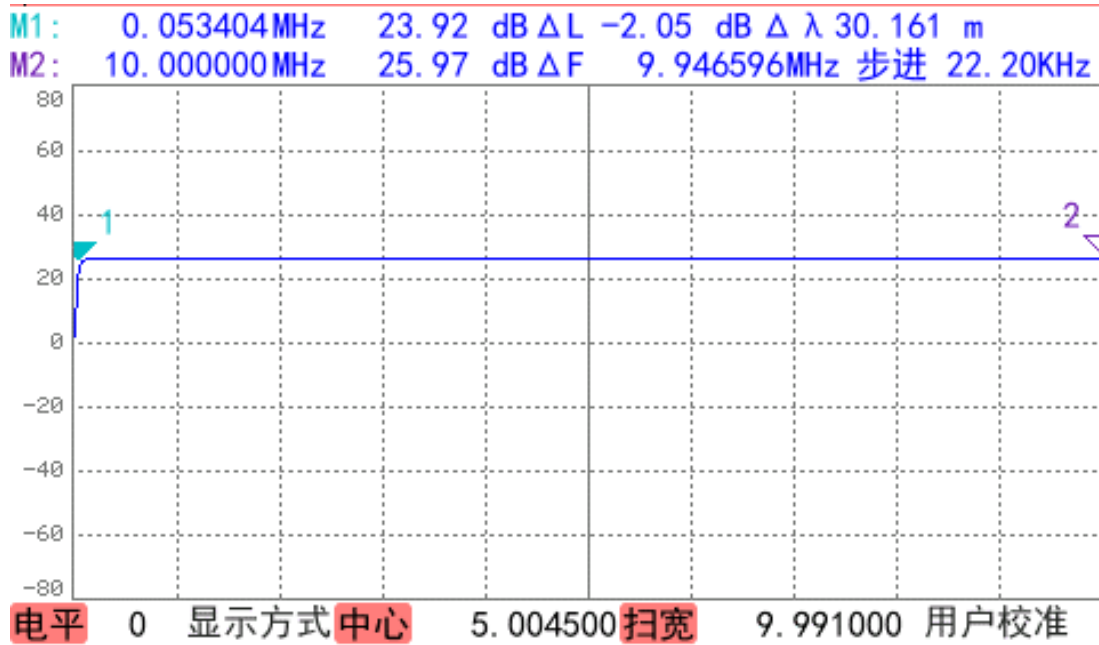

Gain vs Frequency from 50kHz to 10MHz



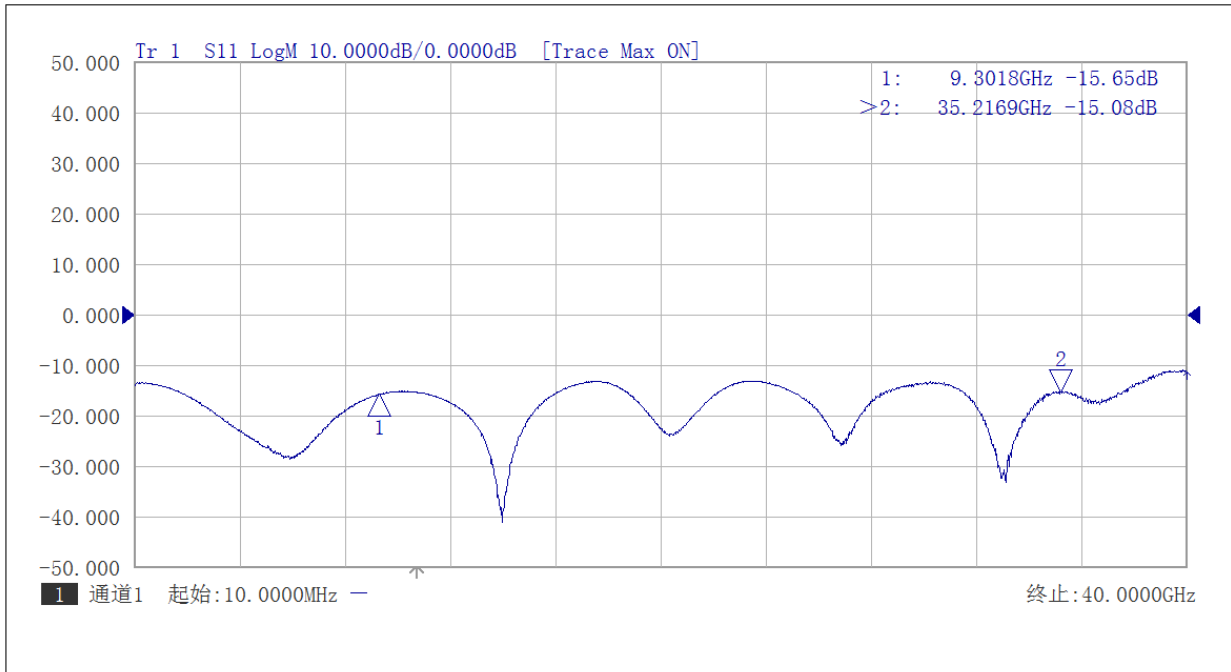

Input Return Loss vs Frequency

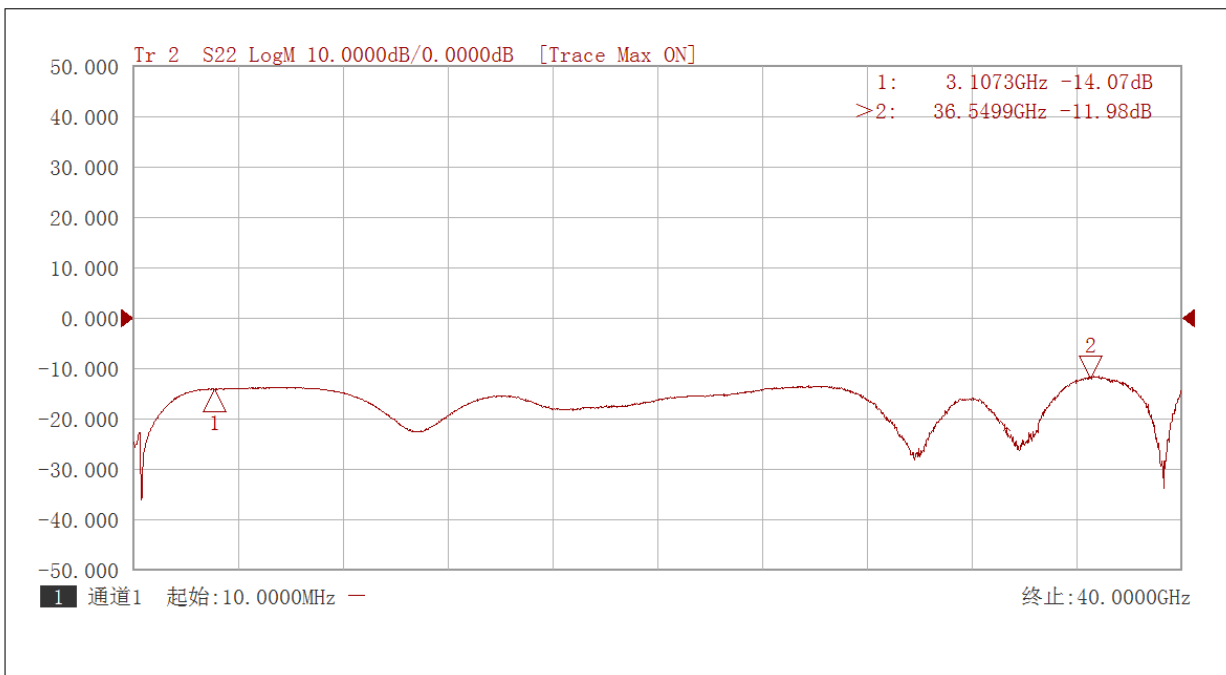

Output Return Loss vs Frequency



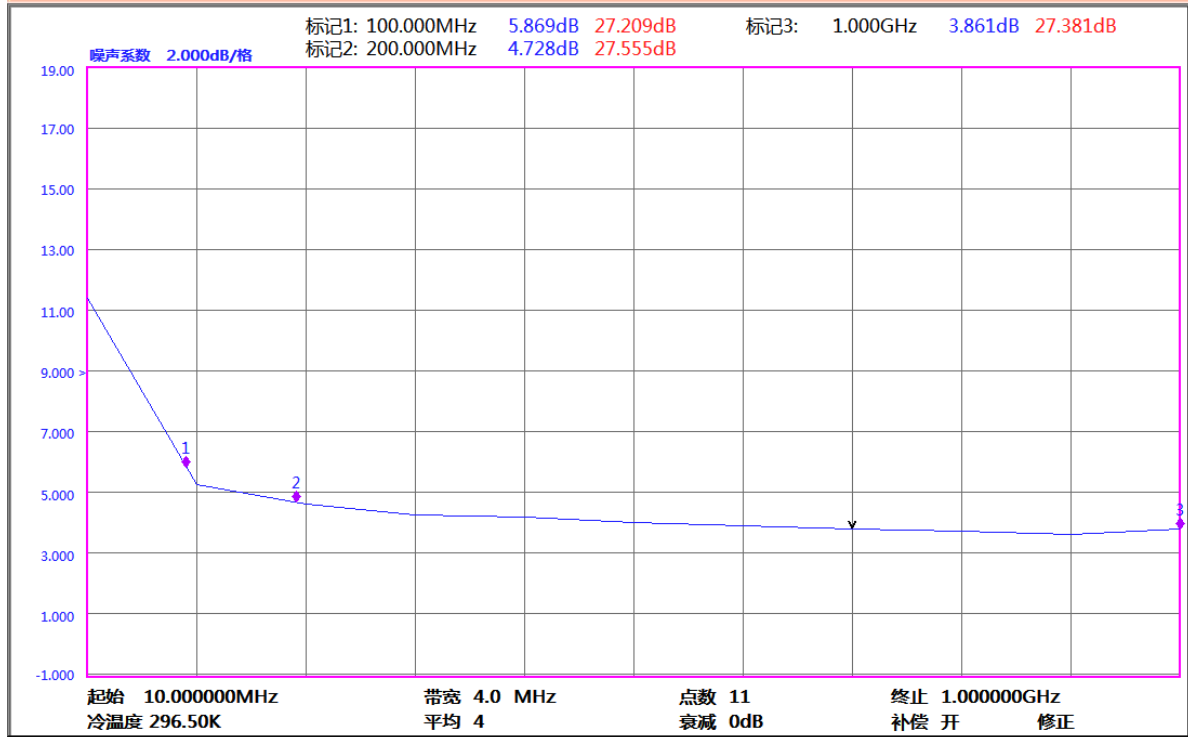

NF test 10MHz to 1GHz

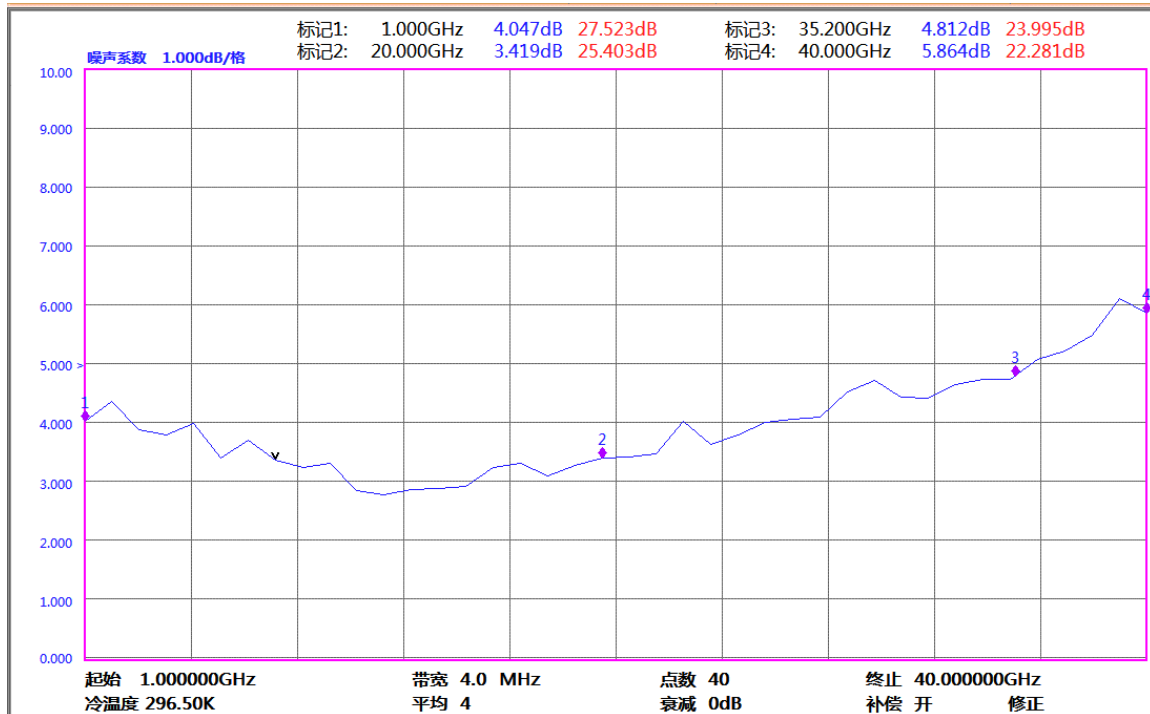

NF Test from 1GHz to 40GHz



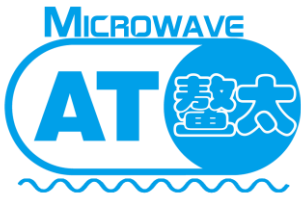

AT-LNA-0040-2304Y

50kHz-40GHz Low Noise Amplifier

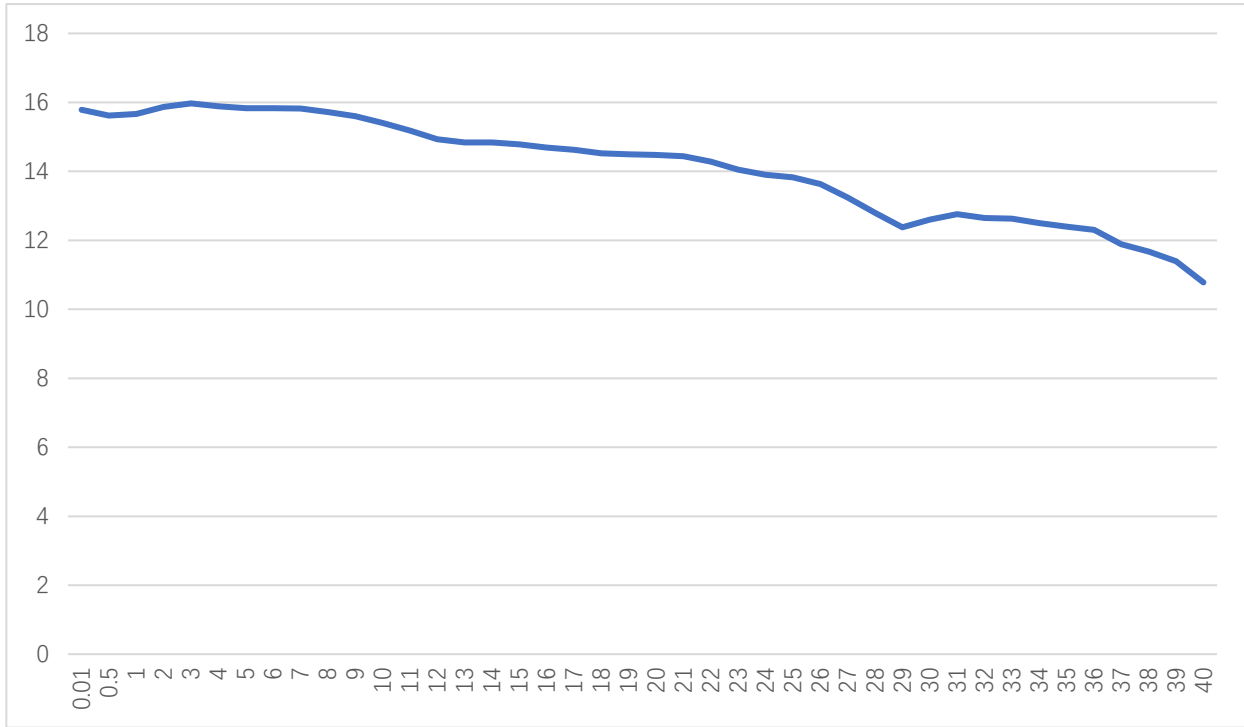

Psat vs Frequency , Pin=0dBm

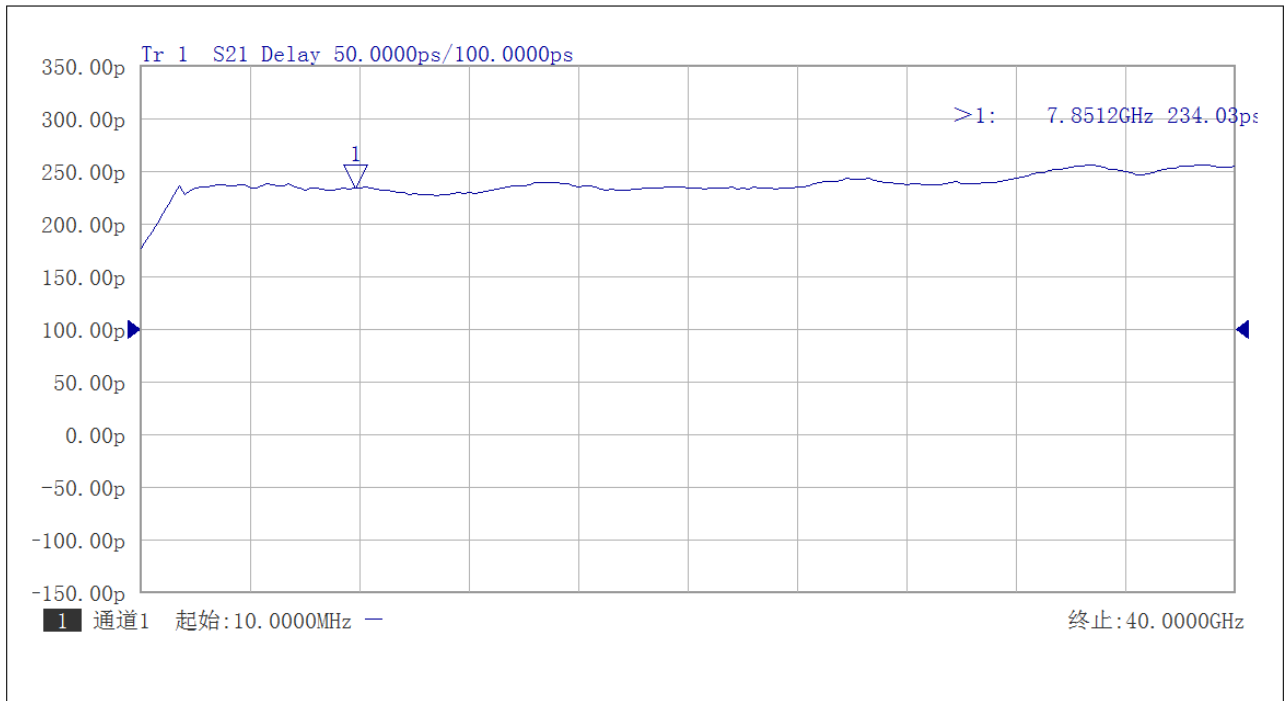

Phase Delay vs Frequency



Dimension: (unit in mm)

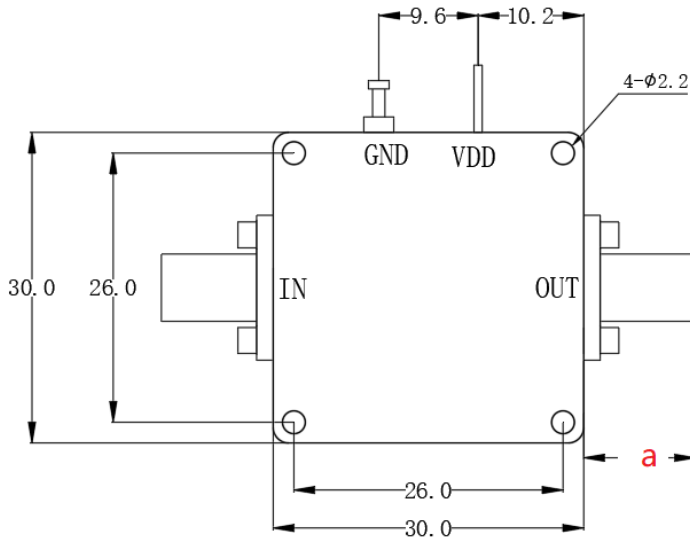

In millimetres

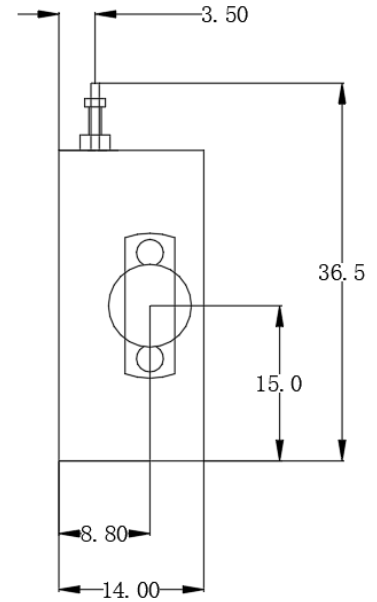

	<26.5GHz	<40GHz	<50GHz	<67GHz
Connector	SMA	2.92mm	2.4mm	1.85mm
Length of a	9.4mm	9.5mm	10.8mm	11.3mm

Note: Female Default. Contact with us for other types.

