

3dB Hybrid 180 Degree

AT-H180-0R712

Feature

- 0.76-12.4GHz Broadband Performance
- Excellent amplitude and phase balance
- High Isolation
- Low VSWR

Electrical Specifications -

Specifications guaranteed from -45 to +85°C, measured in a 50Ω system

Parameter	Frequency Range(GHz)	Min	Typ	Max	Unit
Coupling	0.76-12.4GHz		3		dB
Phase Shift			180		Degree
Amplitude Balance			0.8		dB
Phase Balance			+/- 10		Degree
Insertion Loss			3.3		dB
VSWR			1.6		
Isolation			17		dB
CW/Peak Power			20/3000		W
Weight			270		g
Dimension(LxWxH)			168.9x 41.7 x12.7		

Order Information

Part Number	Description
AT-H180-0R712	0.76-12.4GHz 180Degree Hybrid With SMA Female Connectors

Consult factory for other connectors option

Dimension

Unit: mm/Degree

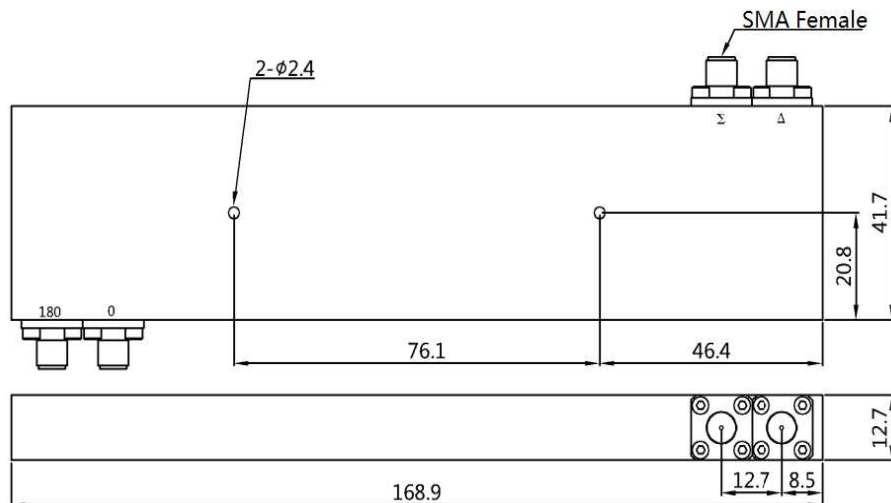

AT Microwave

RM1204,NO.2911,North Zhongshan RD, Putuo District , Shanghai ,China, 200063
 Tel:+8621-6229 1233 Email:sales@atmicrowave.com www.atmicrowave.com

3dB Hybrid 180 Degree

AT-H180-0R712

Typical Performance

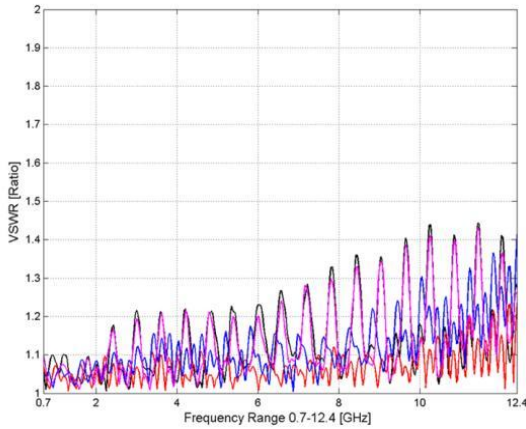

Figure 1: Input /Output VSWR

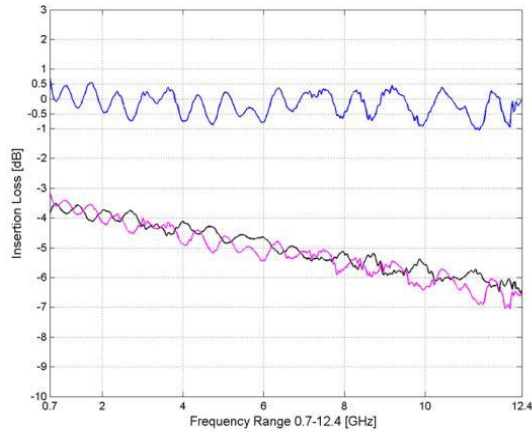

Figure 2: Delta IN IL & Amp Balance

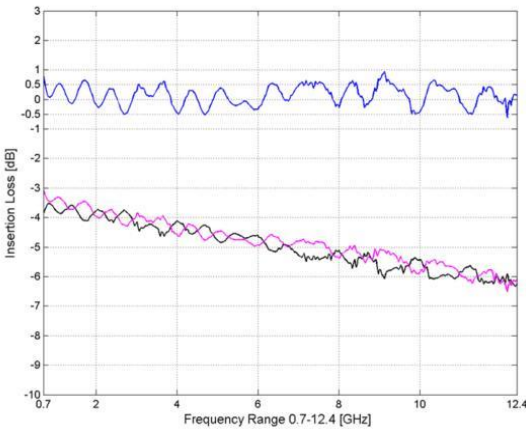

Figure 3: Sigma IN IL & Amp Balance

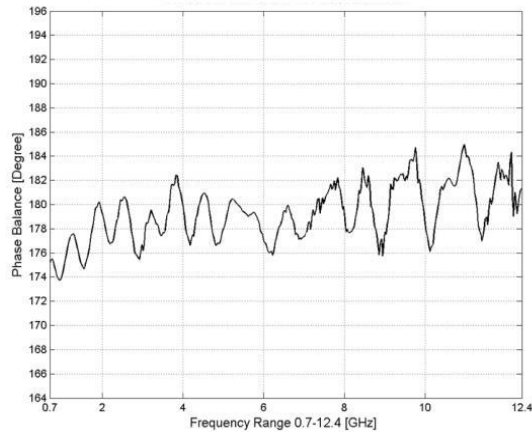

Figure 4: Delta IN Phase Balance

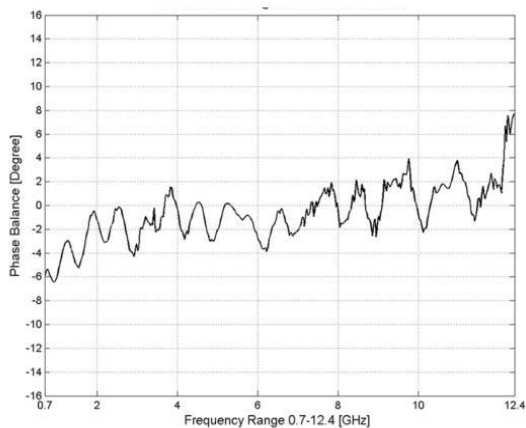

Figure 5: Sigma IN Phase Balance

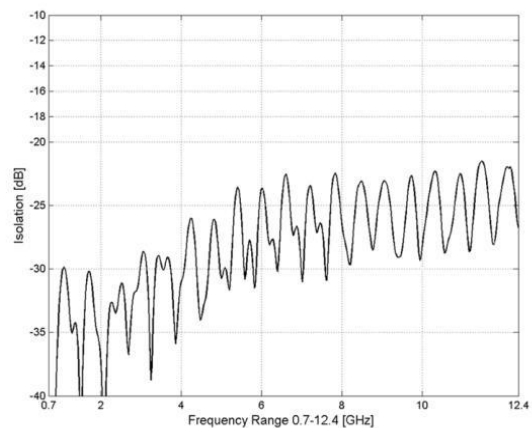

Figure 6: 0-180 Degree Isolation

AT Microwave reserves the right to make changes to the information contained herein without notice.

AT Microwave

RM1204,NO.2911,North Zhongshan RD, Putuo District , Shanghai ,China, 200063

Tel:+8621-6229 1233 Email:sales@atmicrowave.com www.atmicrowave.com