

FMCW Tx/Rx Module, 90-98GHz



Product Overview

AT-FMCW-9098TR is Tx and Rx module for FMCW application. The Tx channel integrated with X8 Multiplier and Power amplifier at $P_{out}=+20\text{dBm}$. The Rx channel is with 20dB gain and 4dB Low NF.

Both IF input port, IQ Output ports are SMA Female, and Tx output and Rx input port are WR-10.

More information, please visit www.atmicrowave.com

Feature

- ✓ Frequency: 90-98GHz
- ✓ Tx Pout=+20dBm
- ✓ X8 Multiplier inside
- ✓ Rx NF: 4dB
- ✓ RX Gain: 20dB

Application

- ✓ FOD Application
- ✓ W Imaging
- ✓ Test Equipment
- ✓ ROF
- ✓ Defense

Diagram Block

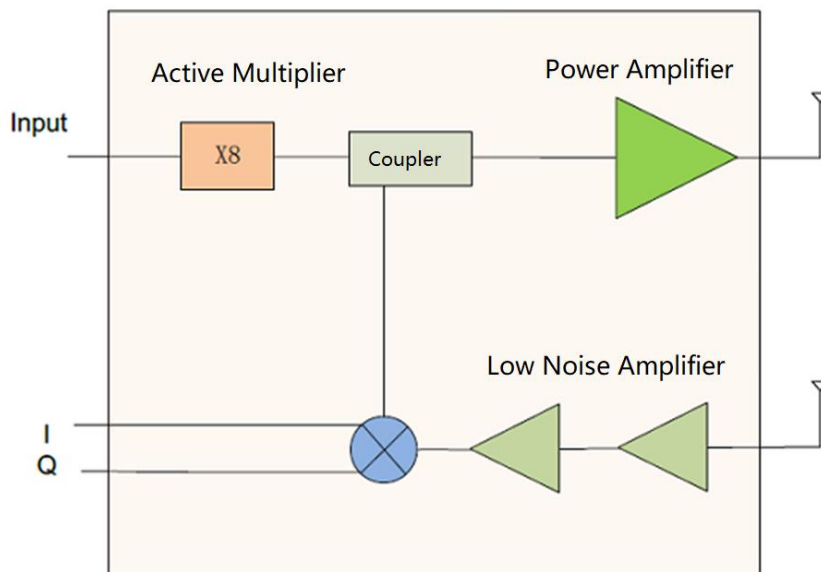



AT-FMCW-9098TR

W Band Tx and Rx Module

Tx Spec at 25C

Parameters	Min	Typical	Max
Frequency		90-98GHz	
Output Power	+18	+20dBm	
Multiplier Factor		8	
Input Frequency		11.25-12.25GHz	
Input Power	0	+5dBm	+8
X7/X9 Harmonics	-18	-30dBc	

Rx Spec at 25C (test at IF=1GHz if not specified.)

Parameters	Min	Typical	Max
Frequency		90-98GHz	
RF IN Power		-40dBm	-20dBm
NF		4dB	
RF to IF Gain		20dB	
IF Bandwidth		DC-6GHz	
IQ Amplitude Balance		+/-1dB	3
IQ Phase Balance		+/-5Degree	10

DC Characteristic

Parameters	Min	Typical	Max
Vdd		+5V	+12V
Idd (NO RF)		0.6A	
IDD (Psat Output)		0.7A	
Connector		DB9/J30K-9ZKP	





AT-FMCW-9098TR

W Band Tx and Rx Module

Mechanical Information

Parameter	Description
TX RF Port	WR-10
TX IF Inpu Port	SMA Female
RX RF Port	WR-10
RF IF Output Port	SMA Female
Case Material (Note)	Copper
Finish	Gold Plated
Weight	530g
Dimension	See outline

Note: Aluminium for lighter weight is available according to request

Absolute Maximum Ratings Table

Parameter	Value
Drain Supply	+13V
Rx Input Power	+7 dBm
Tx IF Input Power	+13dBm
Operating Temperature	-00 to +50C
Storage Temperature	-55 to +125C

Notes:

1. Datasheet may be changed according to update of MMIC, Raw materials , process, and so on.
2. This data is only for reference, not for guaranteed specifications.
3. Please contact AT Microwave team to make sure you have the most current data.



J30-9ZKP

PIN	Function	Note
1	+5V~12V	Input Power Supply, Pin1/2 connected together inside
2	+5V~12V	Input Power Supply, Pin1/2 connected together inside
3	GND	
4	SDA	Reserved
5	SCL	Reserved
6-9	NC	

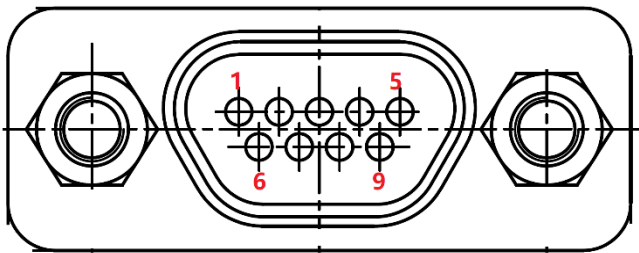

Tx Test Data

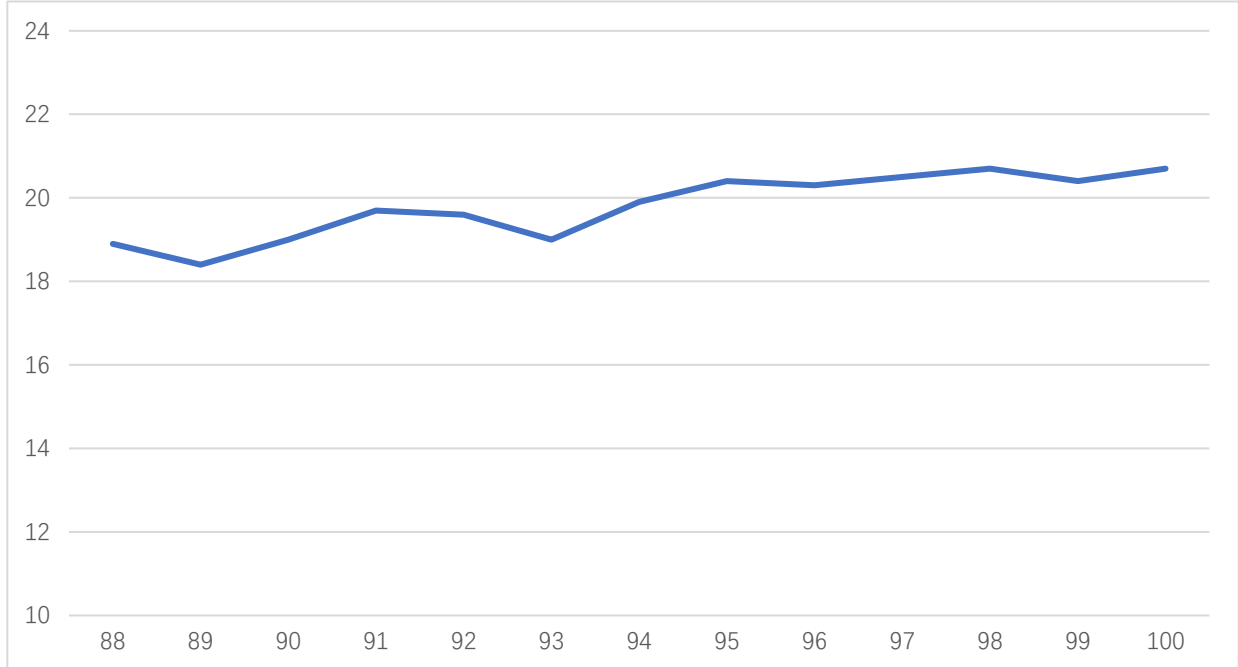

Tx Pout vs Frequency, Pin=+5dBm

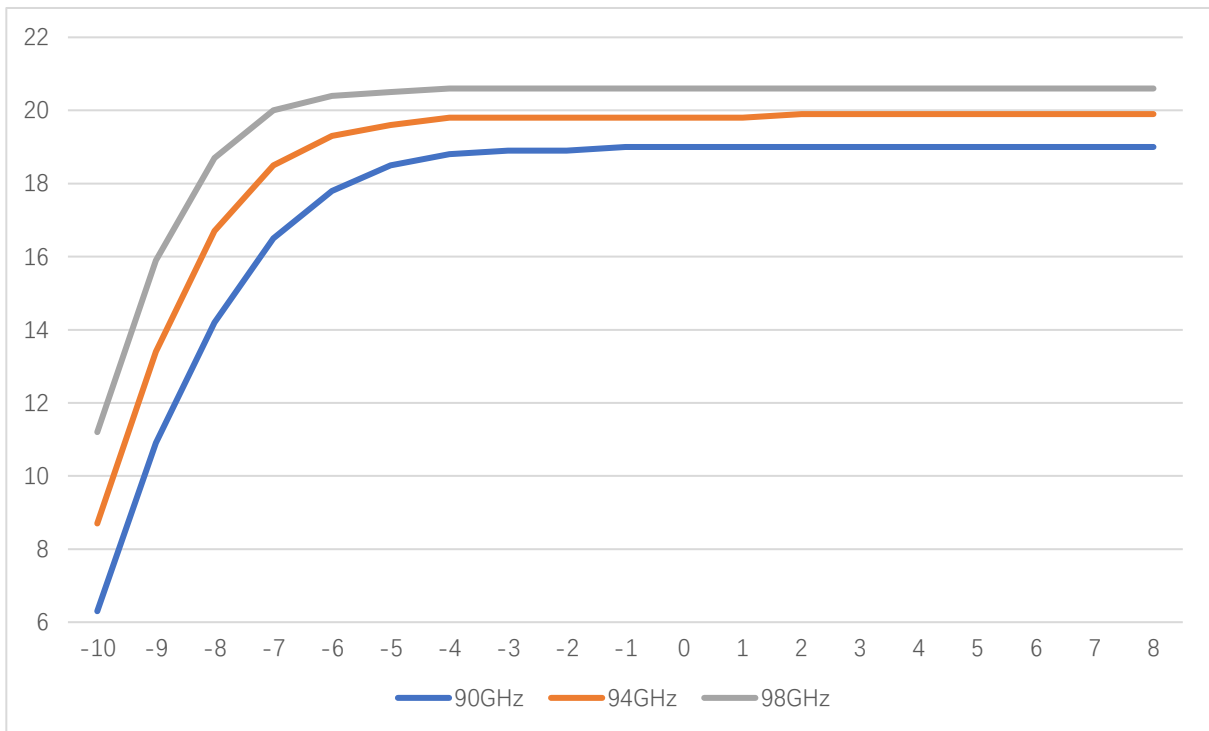

Pout vs Pin at 90/94/98GHz



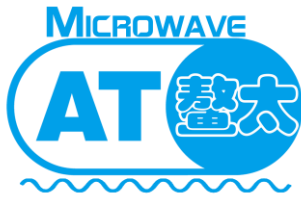

AT-FMCW-9098TR

W Band Tx and Rx Module

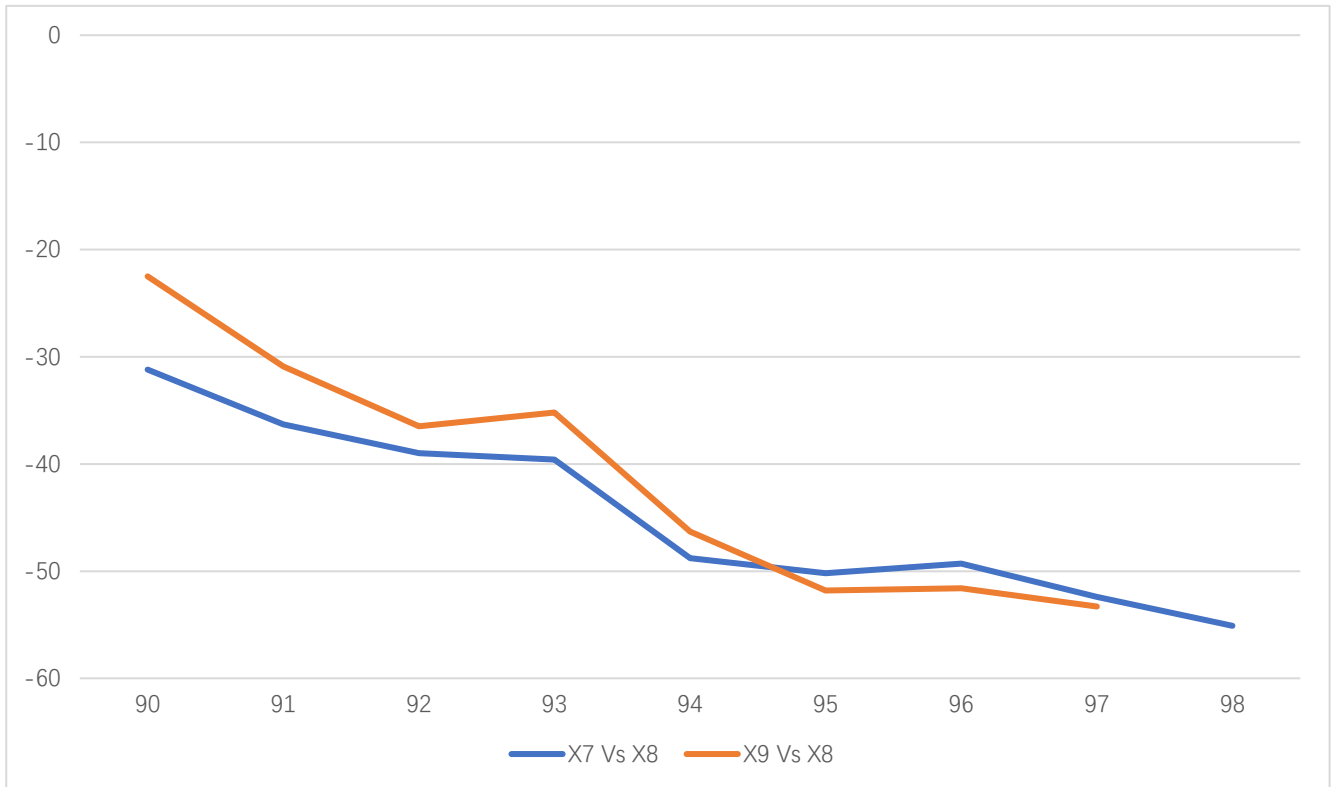

X7/X9 Harmonics Suppression vs X8 Pout



Rx Test 25C

RF Input Power=-40dBm, IF=1GHz

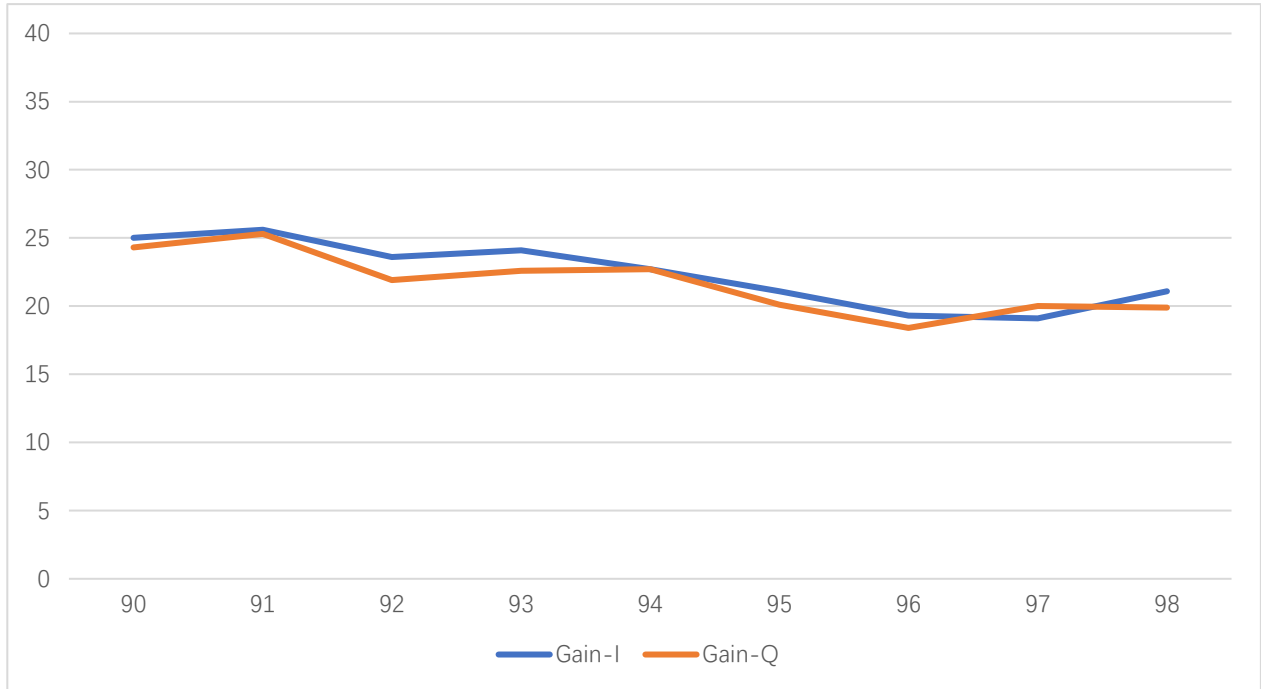

Rx I/Q Gain vs Frequency

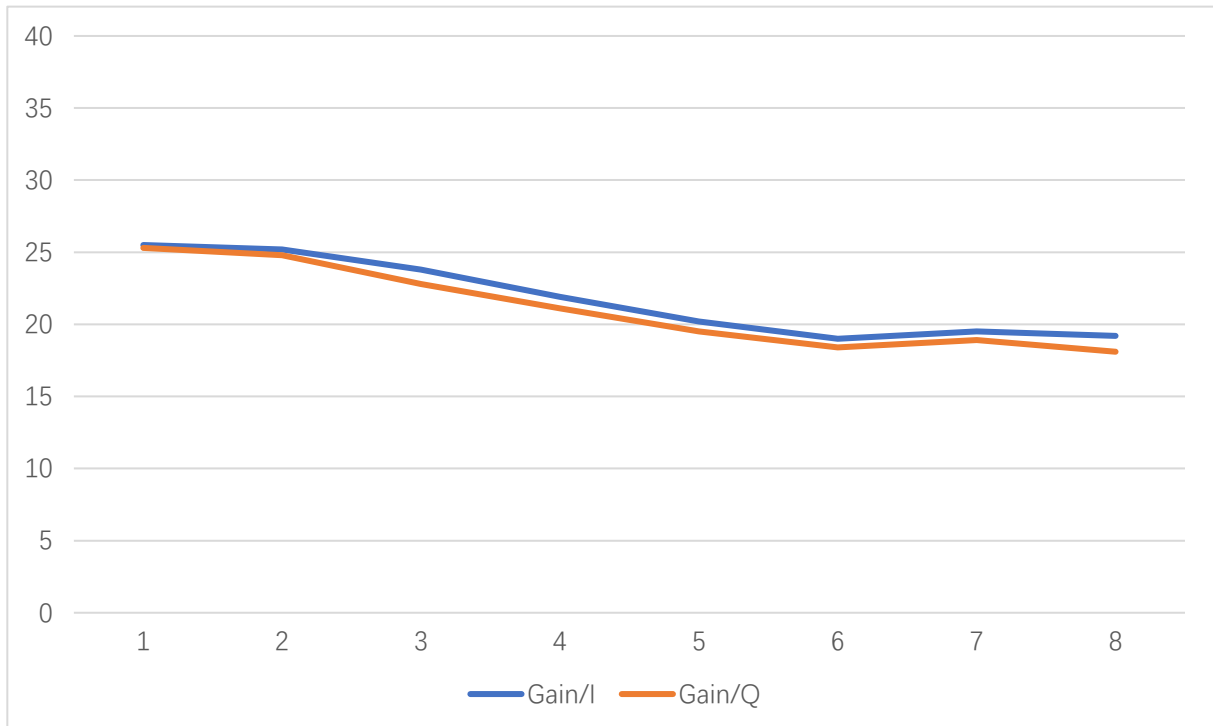

IF Response LO=90GHz



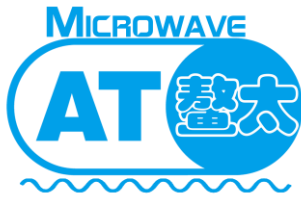

AT-FMCW-9098TR

W Band Tx and Rx Module

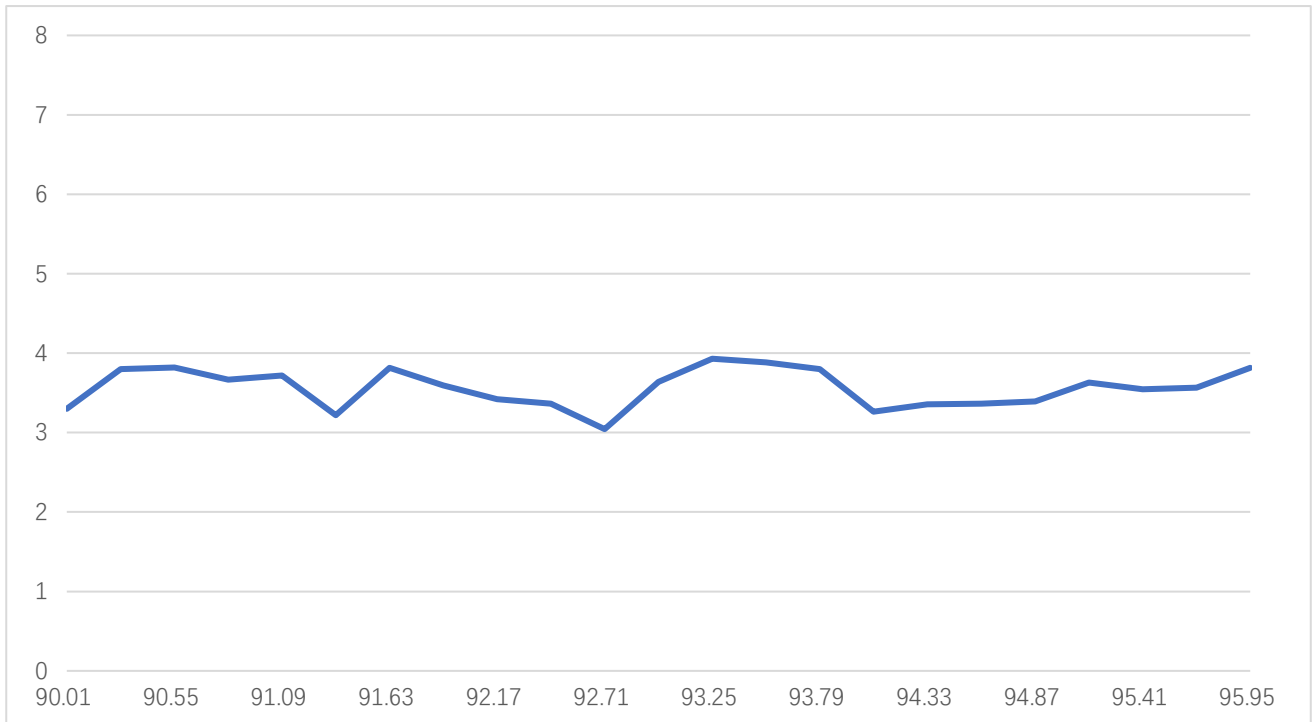

RX NF Test vs Frequency



Dimension (mm)

